



## INSTALLATION MANUAL



# VGREEN EVO® VARIABLE SPEED MOTOR

INSTALLATION MANUAL AND USER GUIDE

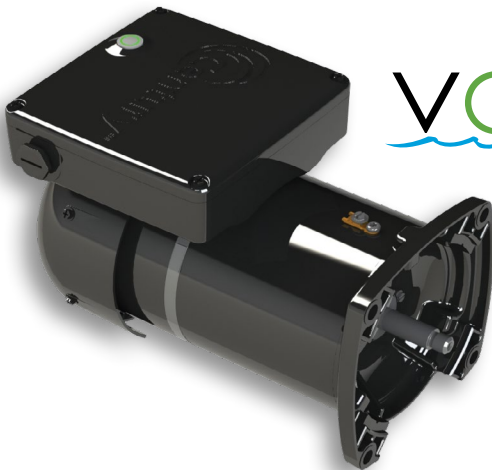

**RegalRexnord**

# VGREEN EVO® VARIABLE SPEED MOTOR

## INSTALLATION MANUAL AND USER GUIDE

---

Safety is emphasized throughout this Installation Manual and User Guide. These are safety alert symbols and signal words. They alert the user to potential personal injury hazards. Obey all safety messages to avoid possible injury or death or damage to equipment and other property.

---

**⚠ WARNING** Indicates a hazardous situation which, if not avoided, could result in death or serious injury.

**⚠ CAUTION** Indicates a hazardous situation that, if not avoided, could result in minor or moderate injury.

**NOTICE** Indicates information considered important, but not hazard-related (e.g. messages relating to property).

**NOTE:** Not a safety message. Used when no injury or equipment failure is a possibility.

---

### GENERAL SAFETY INSTRUCTIONS

#### **⚠ WARNING**

- Read and follow all instructions carefully.
- Disconnect and lock out power before installation and maintenance. Working on or near energized equipment can result in severe injury.
- Read and understand the information in this section and in this manual completely before installing, operating or maintaining this equipment. Failure to follow this instruction could result in severe injury or death.

#### **⚠ CAUTION**

- Perform periodic inspections. Equipment may fail prematurely and could become unsafe if not properly inspected and maintained. Failure to follow this instruction could result in mild or moderate personal injury.
- 

### TABLE OF CONTENTS

<b>1.0 INTRODUCTION</b> .....	3
<b>2.0 QUICK START INSTRUCTION</b> .....	4
<b>3.0 WIRING</b> .....	4
<b>4.0 OPERATING THE VGREEN EVO MOTOR</b> .....	5
4.1 Operating Mode .....	6
4.2 Override Mode.....	7
4.3 Pause Mode .....	8
4.4 Schedule Check Mode.....	9
4.5 Schedule Set Mode .....	10-22
4.5.1 Schedule Set A .....	10

# TABLE OF CONTENTS

Continued

4.5.2 Schedule Set B .....	12
4.5.3 Schedule Set A and B Programming .....	14
4.5.4 Schedule Set C (Water Feature Mode) .....	15
4.5.5 Schedule Set D (Century Connect™ Automation Mode).....	16-22
<b>5.0 PRIMING .....</b>	<b>23</b>
<b>6.0 FREEZE PROTECTION .....</b>	<b>23</b>
<b>7.0 CARE AND MAINTENANCE .....</b>	<b>23</b>
<b>8.0 FAULT STATUS, MANUAL RESTART AND POWER OUTAGES .....</b>	<b>24</b>
<b>9.0 DIP SWITCH CONFIGURATION - QUICK START REFERENCE .....</b>	<b>25</b>
<b>10.0 TROUBLESHOOTING GUIDE .....</b>	<b>26</b>

---

## 1.0 INTRODUCTION

The VGreen Evo® motor is a cost-effective variable speed replacement pool pump motor designed to provide pool owners with maximum savings over traditional single-speed motors. The variable speed design allows the motor to be programmed at the optimal settings for the pool allowing for energy savings. The VGreen Evo motor offers ease of installation as a direct drop-in replacement for all applications. It features an easy to program user interface that allows for a simplified user experience, making it the perfect choice for your next pool installation or motor replacement.

### VGREEN EVO MOTOR FEATURES:

- Freeze Protection
- Sealed Ball Bearings
- TEFC Design
- Rotation: CCWPE
- Single Phase
- 50/60 Hz
- Variable Speed Operation (600 -3450 RPM)
- 303 Stainless Steel Shaft
- Class F Insulation
- 50°C Ambient
- Dual Voltage 230/115 VAC, Auto-Voltage Detect Enabled Device
- Century Connect™ Automation Mode enables communication with many popular automation systems

### BENEFITS:

- Communicates easily with most automation systems leading to no loss of automation system functionality
- New simplified user interface allows for easier programming and motor setup all with the push of a button
- Lightweight, compact design, and rotatable mains wiring compartment allow for ease of installation
- Available in both square flange and C-Face mounting configurations to allow for replacement versatility
- Water, weather, and UV resistant IPX5 moisture intrusion rating and UV resistant components protect against harsh conditions to extend motor life

## 2.0 QUICK START INSTRUCTION

**NOTICE:** If the VGreen Evo® motor is powered off for any reason, at least 60 seconds must pass before power is reapplied. Failure to provide an adequate delay could result in damage to the motor.

When power is applied to the VGreen Evo motor for the first time it will automatically run the programmed default schedule. This feature ensures that the VGreen Evo motor will re-start in the event of a power outage.

Refer to section 4.5 **Schedule Set Mode** - to view the default operating schedule, or to set the VGreen Evo at another schedule option.

## 3.0 WIRING

### WARNING! SHOCK HAZARD

The VGreen Evo motor must be wired according to the locally adopted version of the National Electrical Code (NEC). A licensed, qualified electrician should complete the wiring for this product. The motor is designed to operate with 230/115 VAC single phase power, and is equipped with auto-voltage detection.

The VGreen Evo motor is designed to handle a direct wire connection. The wire insulation should be stripped to a length of approximately 0.33". The terminal block is capable of handling solid or stranded wire up to 12 AWG in size. The screw for the mains connections should be properly tightened to a torque value of 10 in-lb.

**NOTE:** If using the VGreen Evo Automation Mode, please reference the automation system manual for additional power wiring diagrams and instructions.

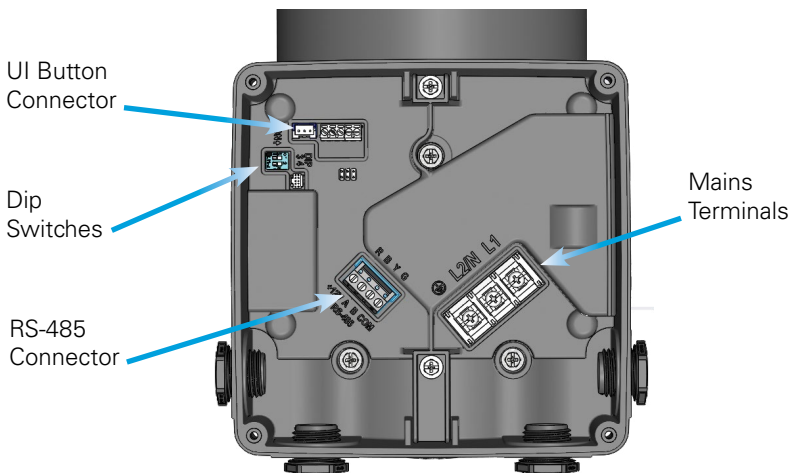

**VGreen Evo® Motor**

## 4.0 OPERATING THE VGREEN EVO® MOTOR

The VGreen Evo® motor is equipped with 5 different modes that can all be reached by a series of button presses on the user interface as outlined in sections 4.1 through 4.5.

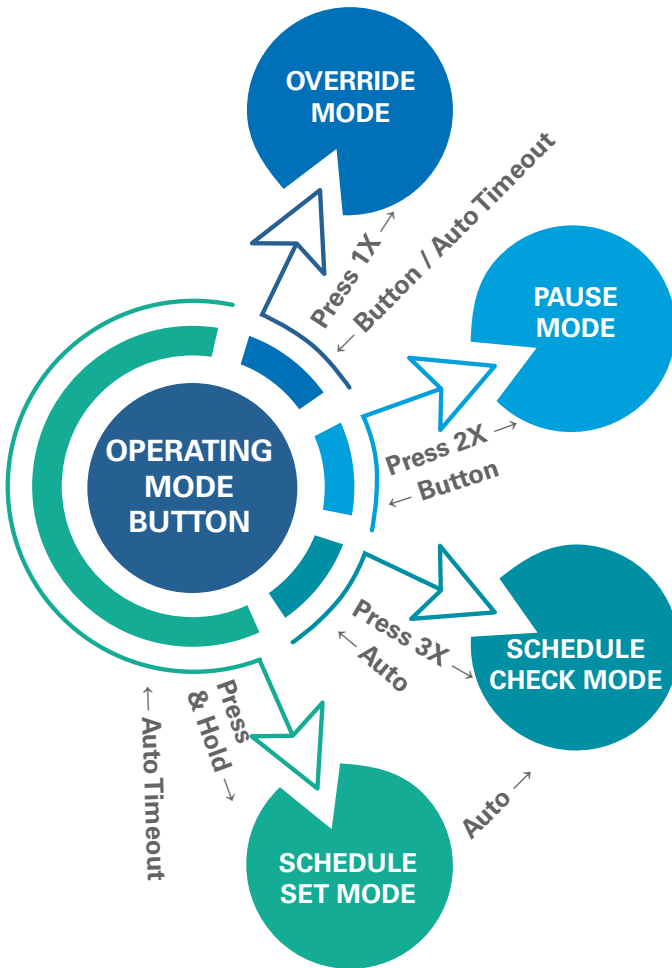

**NOTE:** The user can only reach each mode from the operating mode, with the exception of moving from **Schedule Set Mode** to **Schedule Check Mode**.

## 4.1 OPERATING MODE

**Operating Mode** will automatically start once power is applied to the motor and will run the preset or user defined schedule. To turn the motor off, power must be disconnected. The below illustrations show the different scenarios possible during **Operating Mode**:

While the power is off, the light will be off and the motor will NOT be running:

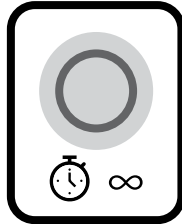

**NOT RUNNING**  
RUNNING (any speed)  
RUNNING (high speed)

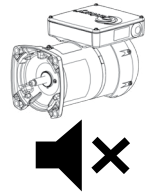

While in **Operating Mode (during Priming)** light will be on continuously and motor will be running:

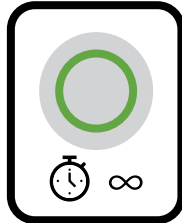

**NOT RUNNING**  
RUNNING (any speed)  
RUNNING (high speed)

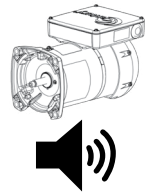

While in **Operating Mode (during Schedule @ Running RPM)** the light will be on continuously and the motor will be running:

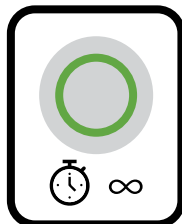

**NOT RUNNING**  
RUNNING (any speed)  
RUNNING (high speed)



While in **Operating Mode (during Schedule @ 0 RPM)** the light will be on continuously and the motor will NOT be running:

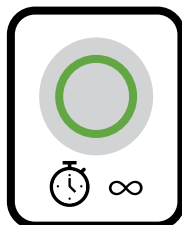

**NOT RUNNING**  
RUNNING (any speed)  
RUNNING (high speed)

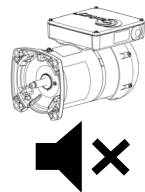

## 4.2 OVERRIDE MODE

The VGreen Evo® motor is equipped with an **Override Mode**, which can be engaged to temporarily run at maximum speed, which is 3450 RPM if the motor is currently operating at less than 3450 RPM. If the motor is operating at 3450 RPM there will be no change in motor speed. Follow the illustrations below to operate **Override Mode**:

To enter **Override Mode**,  
PRESS button 1 time:

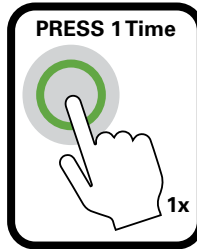

While in **Override Mode**, light will blink slowly:

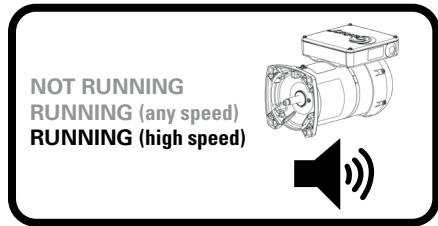
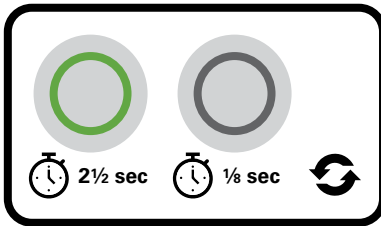

To exit **Override Mode**,  
PRESS and HOLD button  
for 3 seconds then  
release:

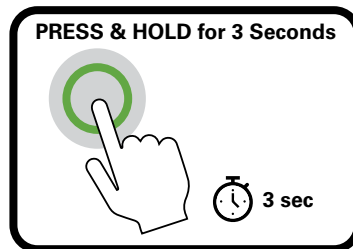

Automatic timeout of **Override Mode**:

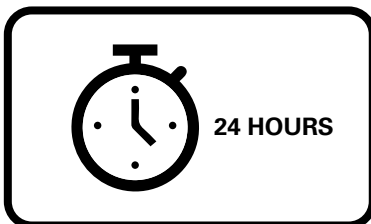

### 4.3 PAUSE MODE

The VGreen Evo® motor is equipped with a **Pause Mode** that will allow the user to temporarily stop the VGreen Evo motor for maintenance work without disrupting the 24 hour schedule (i.e., for backwashing the filter). If the VGreen Evo motor is currently running, the user can follow the below illustrations to operate **Pause Mode**:

To enter **Pause Mode**,  
PRESS button 2 times:

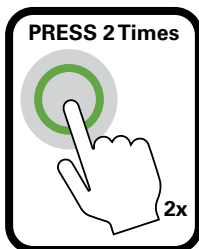

While in **Pause Mode**, light will blink slowly:

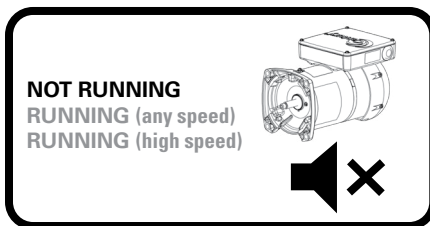
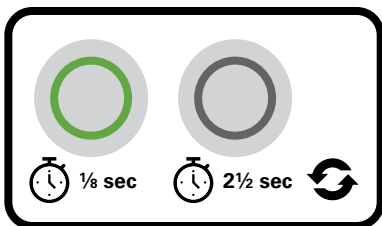

To exit **Pause Mode**, PRESS  
and HOLD button for 3  
seconds then release:

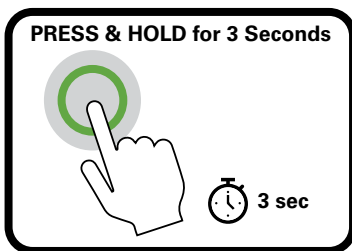

There is NO automatic timeout of **Pause Mode**:





## 4.4 SCHEDULE CHECK MODE

The VGreen Evo® motor is equipped with a **Schedule Check Mode** that will allow the user to check which of the 8 available schedules the motor is currently operating. The user can follow the below illustrations to operate **Schedule Check Mode**:

To enter **Schedule Check Mode**, PRESS button 3 times. After pressing the button 3 times, the light will turn on for 3 seconds then turn off:

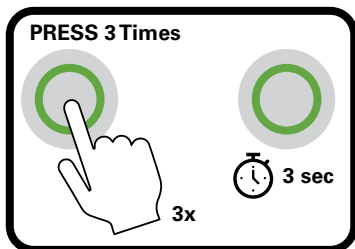

Once the light turns back on, begin counting. The light will blink 1-8 times depending upon the set schedule. Then, the light will turn off for 3 seconds:

**NOTE:** When operating in **Schedule Set C**, the light will blink 1-20 times depending on the set speed. The speed is set in 100 RPM increments with a base speed of 1,000 RPM. For example, if the light blinks 10 times, the speed set is 2,000 RPM. If the light does not blink, speed is set at the default 1,000 RPM.

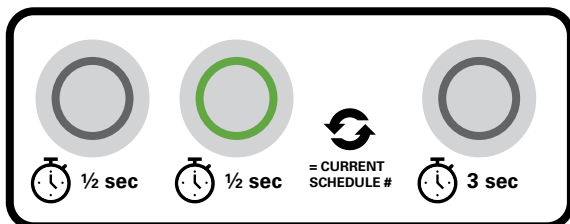

Once the light blinking sequence is complete, the light will turn off and the motor will automatically return to **Operating Mode**:

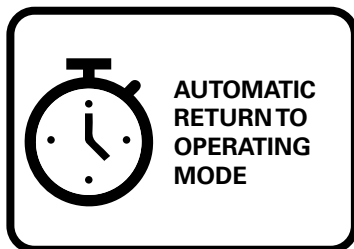

**NOTE:** You can enter **Schedule Check Mode** while the motor is in **Operating Mode**.

## 4.5 SCHEDULE SET MODE

The VGreen Evo® motor is equipped with four sets of schedules: Schedule Set A and Schedule Set B, are energy efficient schedules designed for use with on/off timer and no controller applications. For instructions on programming the motor for Schedule Set A & B please see page 14. There are two additional functional capabilities, Schedule Set C (Water Feature Mode - see page 15) and Schedule Set D (Century Connect™ Automation Mode - see page 16) for dip switch configurations.

### 4.5.1 SCHEDULE SET A

The 8 pre-programmed operating schedules for the **Schedule Set A** can be seen in the table below.

To select this set of schedules, the dip switch positions must be set to: #3 OFF, #4 OFF.

SCHEDULE SET A				
SCHEDULE	PRIME (WHEN MOTOR STARTS FROM A STOPPED POSITION)			
		HOURS 0-2	HOURS 2-4	HOURS 4-6
Schedule 1 (Factory Default)	<b>3 minute prime @ 3450 RPM</b>	<b>3450 RPM</b>	<b>2750 RPM</b>	<b>1750 RPM</b>
Schedule 2	3 minute prime @ 3450 RPM	<b>3450 RPM</b>	<b>2850 RPM</b>	<b>1850 RPM</b>
Schedule 3	3 minute prime @ 3450 RPM	<b>3450 RPM</b>		<b>1750 RPM</b>
Schedule 4	3 minute prime @ 3450 RPM	<b>3250 RPM</b>	<b>1150 RPM</b>	
Schedule 5	3 minute prime @ 3450 RPM	<b>1725 RPM</b>		
Schedule 6	None	<b>WATER FEATURE ONLY (1100 RPM)</b>		
Schedule 7	None	<b>WATER FEATURE ONLY (1725 RPM)</b>		
Schedule 8	None	<b>WATER FEATURE ONLY (3450 RPM)</b>		

## 4.5.1 SCHEDULE SET A - CONTINUED

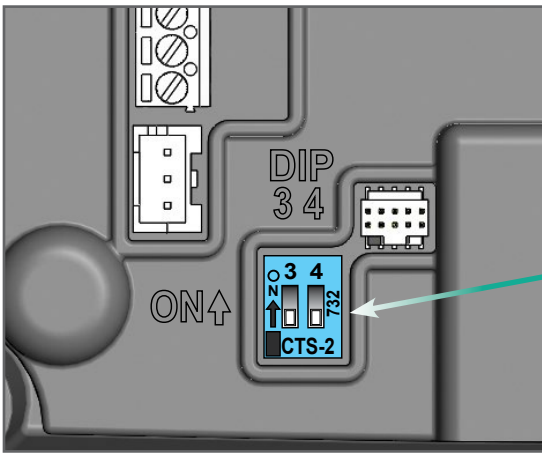

## SCHEDULE SET A

### 24 HOURS

#### TIME

HOURS 6-8	HOURS 8-10	HOURS 10-12	HOURS 12-18	HOURS 18-24
1750 RPM		1150 RPM	0 RPM	
1850 RPM		1250 RPM	0 RPM	
1750 RPM	1150 RPM		0 RPM	
1150 RPM		3250 RPM	0 RPM	
1725 RPM				
FOR USE WITH CONNECTED POOL PUMP TIMER				
FOR USE WITH CONNECTED POOL PUMP TIMER				
FOR USE WITH CONNECTED POOL PUMP TIMER				

## 4.5.2 SCHEDULE SET B

The 8 pre-programmed operating schedules for **Schedule Set B**: California Energy Commission 2021 Compliant Schedules can be seen in the table below.

To select this set of schedules the dip switch positions must be set to: #3 ON, #4 OFF.

<b>SCHEDULE SET B: CALIFORNIA ENERGY COMMISSION 2021 COMPLIANT SCHEDULES</b>				
<b>SCHEDULE</b>	<b>PRIME</b> (WHEN MOTOR STARTS FROM A STOPPED POSITION)			
		<b>HOURS 0-2</b>	<b>HOURS 2-4</b>	<b>HOURS 4-6</b>
<b>Schedule 1</b> (Factory Default)	<b>3 minute prime @ 3450 RPM</b>	<b>3450 RPM</b>	<b>2850 RPM</b>	
Schedule 2	3 minute prime @ 3450 RPM	<b>3350 RPM</b>	<b>2750 RPM</b>	
Schedule 3	3 minute prime @ 3450 RPM	<b>3250 RPM</b>	<b>2650 RPM</b>	
Schedule 4	3 minute prime @ 3450 RPM	<b>3150 RPM</b>		<b>2550 RPM</b>
Schedule 5	3 minute prime @ 3450 RPM	<b>3050 RPM</b>		<b>2450 RPM</b>
Schedule 6	3 minute prime @ 3450 RPM	<b>2950 RPM</b>		<b>2350 RPM</b>
Schedule 7	3 minute prime @ 3450 RPM	<b>3450 RPM</b>	<b>2850 RPM</b>	
Schedule 8	3 minute prime @ 3450 RPM	<b>2950 RPM</b>		<b>2350 RPM</b>

## 4.5.2 SCHEDULE SET B - CONTINUED

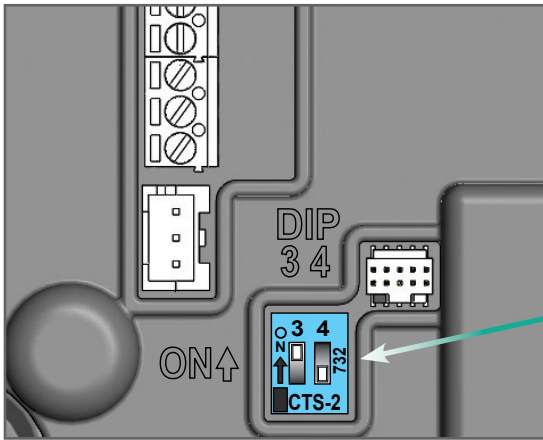

Dip switch positions set to: #3 ON, #4 OFF.

### SCHEDULE SET B: CALIFORNIA ENERGY COMMISSION 2021 COMPLIANT SCHEDULES

#### 24 HOURS

#### TIME

HOURS 6-8	HOURS 8-10	HOURS 10-12	HOURS 12-18	HOURS 18-24
2250 RPM	1550 RPM		0 RPM	
2150 RPM	1450 RPM		0 RPM	
1950 RPM	1350 RPM		0 RPM	
2550 RPM	1850 RPM		1250 RPM	0 RPM
2450 RPM	1750 RPM		1150 RPM	0 RPM
2350 RPM	1650 RPM		1050 RPM	0 RPM
2250 RPM		1550 RPM		
2350 RPM		1650 RPM		1050 RPM

### 4.5.3 SCHEDULE SET A AND B PROGRAMING

Once the dip switches are in the correct position, cycle power to the motor to enter the correct Schedule Set. The user can then select which of the 8 pre-programmed operating schedules they would like the VGreen Evo® motor to run in by entering **Schedule Set Mode**.

The user can follow the below illustrations to operate **Schedule Set Mode**:

To enter **Schedule Set Mode**, PRESS and HOLD button for 3 seconds then release:

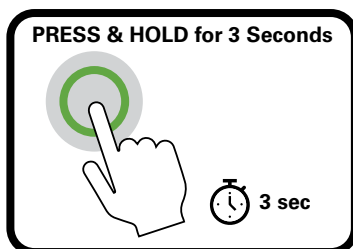

While in **Schedule Set Mode**, the light will blink quickly:

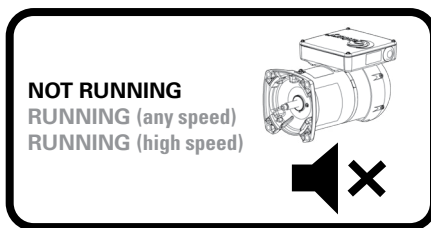
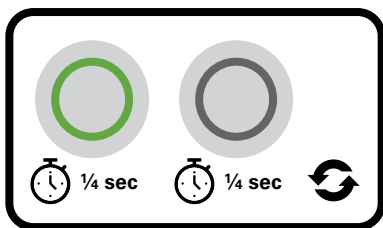

To set the desired schedule, PRESS the button the same number of times as the schedule number. For example, to set schedule 8, PRESS the button 8 times and then PRESS and HOLD for 3 seconds, then release:

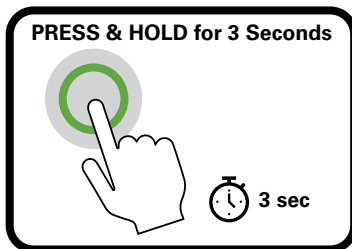
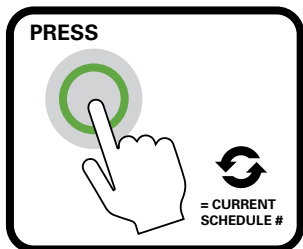

**NOTE:** To confirm the newly set schedule, the motor will automatically go into **Schedule Check Mode**. Refer to section 4.4 for more information on **Schedule Check Mode**. If at any time the motor does not enter **Schedule Check Mode** after inputting the desired schedule, repeat the steps above. If no schedule is set, the motor will automatically exit **Schedule Set Mode** and revert to the previously set schedule after 45 seconds of inactivity.

**NOTE:** The motor start time begins when power is initially applied to the motor. If the user changes the schedule and does not cycle power to the motor, the start time of the new schedule will remain the same as the previous schedule.

#### 4.5.4 SCHEDULE SET C WATER FEATURE MODE

**NOTICE:** While in **Schedule Set C**, both Freeze Protection and priming are disabled.

To run **Schedule Set C Water Feature Mode**, the dip switches must be set to #3 OFF and #4 ON. Once the dip switches are in the correct position, cycle power to the motor to enter **Schedule Set C**.

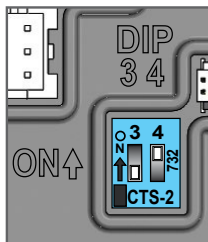

The motor will now default to run at the single speed of 1000 RPM upon powering on. There will be no priming or additional run steps.

To change **Schedule Set C**, PRESS and HOLD button for 3 seconds.

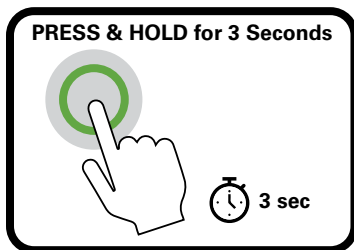

The motor will now allow for speed selection, starting at 1000 RPM.

To increase the speed by 100 RPM, PRESS button 1 time.

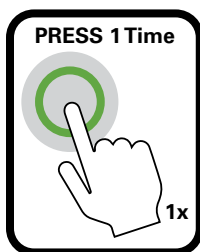

#### 4.5.4 SCHEDULE SET C WATER FEATURE MODE - CONTINUED

After pressing the button, the motor will immediately change speed. The button press can be repeated as many times as desired. The maximum reachable speed is 3000 RPM. The motor will not change with an additional short PRESS of the button once 3000 RPM has been reached.

To save the selected speed, PRESS and HOLD button for 3 seconds.

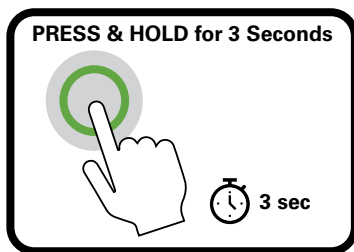

This will allow the motor to start in **Schedule Set C** the next time it is powered on. If no speed is saved, the motor will time out within 60 seconds of the last button PRESS. This will return the motor to 1000 RPM upon next start-up.

Once **Schedule Set C** has been programmed, the motor will automatically go into **Schedule Check Mode**. If at any time the motor does not enter **Schedule Check Mode** after inputting the desired schedule, or if speed of **Schedule Set C** needs to be changed, repeat the steps above.

**NOTE:** **Schedule Check Mode** can also be used to check the speed of **Schedule Set C** at any time by referencing section 4.4.

#### 4.5.5 SCHEDULE SET D CENTURY CONNECT™ AUTOMATION MODE

**NOTICE:** While in **Schedule Set D**, both Freeze Protection and priming are disabled.

**CAUTION!** Power down automation system and refer to the automation system user manual for high voltage wiring connections to motor before continuing.

Century Connect™ functionality is integrated in the VGreen Evo® motor which allows for universal communication with any compatible automation system. The simple plug and play design reduces the need for multiple points of control across various types of pool equipment. This section outlines the process of utilizing Century Connect functionality for easy integration with automation systems.

**NOTE:** Not all automation systems are compatible with variable speed pumps and motors. Refer to the software revision history of your automation system to see if it supports variable speed motor operation. Century Connect Automation Mode is designed to be compatible with a selection of systems. See the next page for additional information.



## 4.5.5 SCHEDULE SET D CENTURY CONNECT™ AUTOMATION MODE - CONT.

### Compatible Systems:

Check our website for additional compatible automation systems.



MANUFACTURER	AUTOMATION SYSTEM	MANUFACTURER	AUTOMATION SYSTEM
Hayward®*	OmniLogic®*	Jandy / Fluidra	iAqualink* 3.1
Hayward	ProLogic®*	Jandy / Fluidra	Aqualink* RS
Hayward	OmniPL™*	Jandy / Fluidra	JEP-R*◇
Hayward	EcoStar®**◇	Pentair®*	EasyTouch®*
Jandy®* / Fluidra®*	iQPump* 1.0	Pentair	Intellitouch®*
Jandy / Fluidra	Aqualink* TCX	Pentair	Intelliconnect*†

◇Denotes that the system connection capabilities are limited to the pump user interface only.

### Century Connect Setup

#### Step 1.

Dip switches #3 and #4 in the VGreen Evo® motor top box should both be flipped to the ON position. This allows the Century Connect Automation Mode to work. Once the dip switches are in the correct position, cycle power to the motor to enter **Schedule Set D** and establish communication with the automation system. Power down motor again before continuing to Step 2.

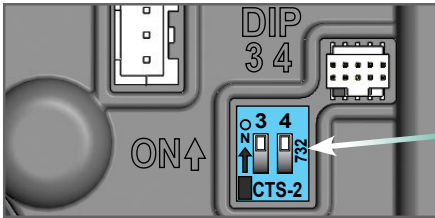

Dip switch positions set to: #3 ON, #4 ON.

#### Step 2.

Communication between the automation system and the VGreen Evo motor should be established using RS-485 connectors. The motor connection will be located in the top box, as referenced in the picture below:

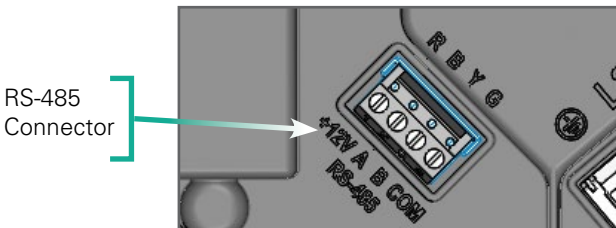

### VGreen Evo® motor

\*Ownership of all trademarks and trade names are expressly claimed or attributed on the back cover.

## 4.5.5 SCHEDULE SET D CENTURY CONNECT™ AUTOMATION MODE - CONT.

### Step 2 Continued

The configuration of wires depends on the automation system selected. The following wiring diagrams show wire orders for the corresponding automation system:

AUTOMATION SYSTEM	WIRING CONFIGURATION	
<b>Hayward®*:</b> OmniLogic®* ProLogic®* OmniPL™* EcoStar®*	<b>Automation System</b> PIN #1 PIN #2 PIN #3 PIN #4	<b>VGreen Evo® Motor</b> R B Y G
<b>Jandy®*/Fluidra®*:</b> iQPump* Aqualink* TCX iAqualink* 3.1 Aqualink RS JEP-R*	<b>Automation System</b> PIN #1 PIN #2 PIN #3 PIN #4	<b>VGreen Evo® Motor</b> R B Y G
<b>Pentair®*:</b> EasyTouch®*	<b>Automation System</b> PIN #4 PIN #3 PIN #2 PIN #1	<b>VGreen Evo® Motor</b> R B Y G NC NC
<b>Pentair:</b> Intellitouch®* Intelliconnect®*	<b>Automation System</b> PIN #4 PIN #3 PIN #2 PIN #1	<b>VGreen Evo® Motor</b> R B Y G NC NC

NC = No Connection Required

\*Ownership of all trademarks and trade names are expressly claimed or attributed on the back cover.

### Step 3.

The system is now connected! Simply re-apply power to the automation system and VGreen Evo® motor, and allow the system to establish connection with Century Connect™ Automation Mode. If present, the system will begin operating based on existing schedules programmed in the automation system. If no schedule exists or to change existing schedules please refer to the automation system user manual for automation programming steps.



### Configuring Multiple Motors

If utilizing either a Jandy®\* Aqualink®\* RS or Pentair®\* EasyTouch®\* automation system with multiple VGreen Evo motors, the user can set a numeric address for each motor. Motors can be addressed 1, 2, 3 or 4 for easy identification. Before addressing the VGreen Evo motor, please be sure it is connected and running with the automation system. If a numeric address has already been set it will remain even if the VGreen Evo motor loses power for any reason.

### Setting Motor Address(es)

#### Step 1.

PRESS and HOLD button for 3 seconds. The light will start blinking quickly when the motor is ready to be addressed.

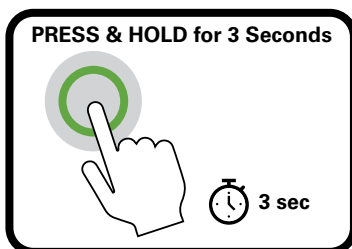

#### Step 2.

To select a numeric address, PRESS button either 1, 2, 3 or 4 times. The motor will then be addressed with the number entered. For example, if the motor address should be #3 PRESS button 3 times. Then PRESS and HOLD button for 3 seconds.

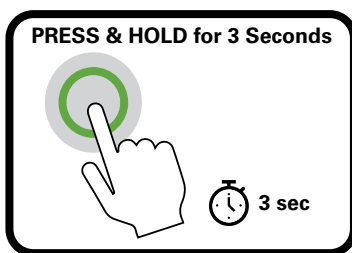
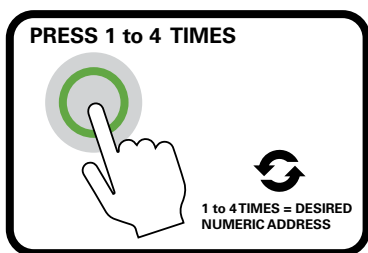

\*Ownership of all trademarks and trade names are expressly claimed or attributed on the back cover.

## 4.5.5 SCHEDULE SET D CENTURY CONNECT™ AUTOMATION MODE - CONT.

### Step 3.

The light on the VGreen Evo® motor will now blink back the selected number and then turn off.

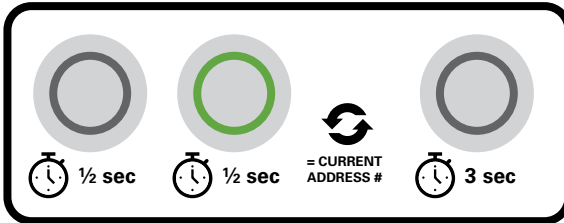

Once the motor has been addressed, please refer to the automation user manual for automation programming steps. If the motor address needs to be changed for any reason, repeat the setup process starting at Step 1.

### Checking The Motor's Numeric Address

#### Step 1.

PRESS the VGreen Evo motor button 3 times. The light will turn ON for 3 seconds and then turn OFF.

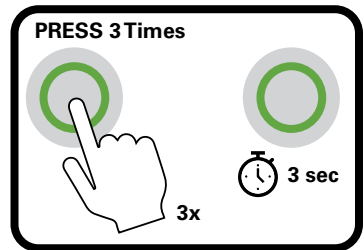

#### Step 2.

The light will begin blinking; the number of blinks is the selected numeric address of the motor. For example, if the motor is #2, the light will blink 2 times.

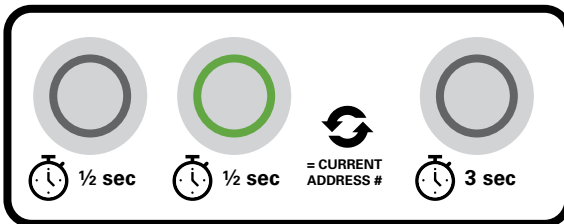

## 4.5.5 SCHEDULE SET D CENTURY CONNECT™ AUTOMATION MODE - CONT.

### Service Mode Button Control For Pentair®\* EasyTouch®\* and Intellitouch®\* Automation Systems

While connected to an automation system in **Schedule Set D**, the light on your VGreen Evo® motor will be continuously lit. All control functionality of the button user interface will be disabled so the motor can function correctly with the automation system. To utilize Service Mode with select automations, see steps below.

**Step 1.** Select "Service Mode" from the automation system panel, and the VGreen Evo button should start to blink slowly to indicate service mode operation has started.

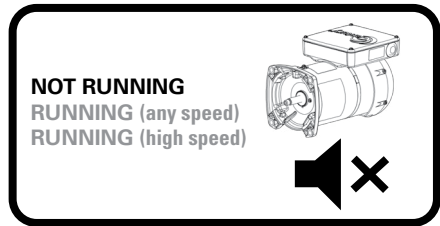
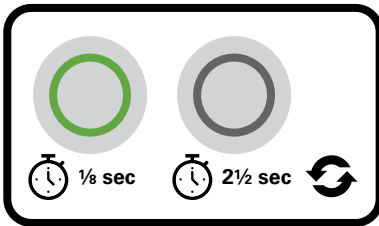

**Step 2.** Press button one time to turn the motor ON. The motor will start running at 2750 RPM and the light will blink.

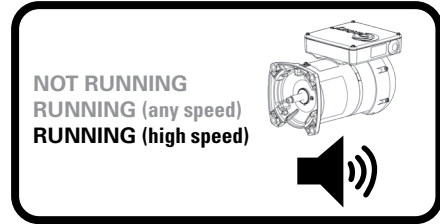
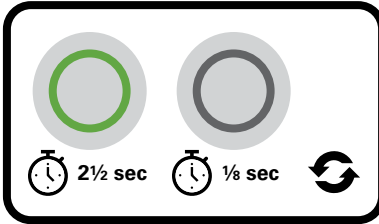

**Step 3.** To turn the motor OFF, press button one time. The light will return to slowly blinking.

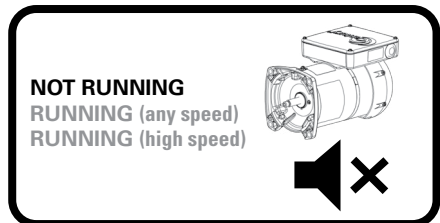
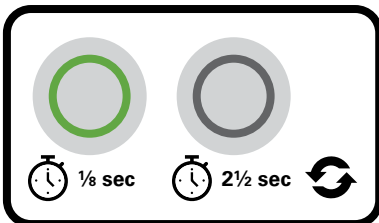

\*Ownership of all trademarks and trade names are expressly claimed or attributed on the back cover.

**Troubleshooting Century Connect™ Automation Mode**

SYMPTOM	POSSIBLE CAUSES	POTENTIAL SOLUTIONS
<p style="text-align: center;"><b>CENTURY CONNECT™ AUTOMATION MODE WILL NOT CONNECT WITH AUTOMATION SYSTEM.</b></p>	<p>Utilizing the Hayward®* Omnilogic®* Automation Systems with the VGreen Evo® motor for the first time.</p>	<p>The motor and automation system should both be power cycled after setup is complete. This should allow for the communication between the systems as each motor connected requires a unique ID generated by the automation system. Please see the automation user manual for additional information.</p>
	<p>Pentair®* Automation Systems communication delays.</p>	<p>Please allow time for the motor to receive information from the automation panel; it could take up to 60 seconds before the new command takes effect.</p>
	<p>Century Connect Automation Mode is not turned on.</p>	<p>Both dip switches #3 and #4 in the VGreen Evo motor top box need to be in the ON position to allow for proper connection to the automation system.</p>
	<p>RS-485 connection is faulty.</p>	<p>The RS-485 connector that comes with the automation system needs to be free of damage and properly placed into the top box of the VGreen Evo motor.</p>
	<p>There is an error within the selected automation system.</p>	<p>The user manual that comes with the automation system can be referenced if the motor connection is working properly, but there are problems with the user interface or controlling specific aspects of the motor.</p>
	<p>Communication loss occurs within the automation panel faults section.</p>	<p>The RS-485 connection should be confirmed to have the correct wiring configuration as outlined in section 7 of this manual.</p>

\*Ownership of all trademarks and trade names are expressly claimed or attributed on the back cover.

## 5.0 PRIMING

The VGreen Evo® motor will always run the priming sequence when starting from the stopped position, except when a schedule is selected that does not include a priming sequence. The prime setting is 3450 RPM for 3 minutes.

## 6.0 FREEZE PROTECTION

In the event that the outside air temperature drops below 39°F, the VGreen Evo motor will automatically turn on and circulate the pool water, except when a schedule is selected that does not include Freeze Protection. The Freeze Protection will run according to the following conditions (utilizing the factory default settings):

- Freeze Protection Turn-On Temperature = 39°F
- Freeze Protection Duration = 1 Hour
- Freeze Protection Speed = 1725 RPM

Once this one-hour period has elapsed, the VGreen Evo motor will check the ambient temperature again. If the temperature is still below the set threshold, the VGreen Evo motor will run for an additional 1 hour.

If the temperature is above the threshold, the VGreen Evo motor will automatically return to the 24-hour based schedule.

## 7.0 CARE AND MAINTENANCE

The VGreen Evo® motor is both reliable and robust in harsh environments. However, general care and maintenance should be followed to ensure optimum reliability of this product. It is recommended to always install a new mechanical shaft seal when installing a new replacement motor, and follow these monthly care and maintenance steps.

- 1. Check for leaks and low water levels** – Inspect equipment and plumbing for water leaks around the equipment pad. A water or air leak may be present if:
  - Moisture is present around the base of the pump
  - Water is leaking from any plumbing or other equipment
  - Air bubbles are present in the pump basket or pool returns

Contact a qualified pool service professional to repair any leaks and prevent your pump running dry which could lead to water damage and bearing failure.

## 8.0 FAULT STATUS, MANUAL RESTART AND POWER OUTAGES

The table below illustrates possible faults that can occur with the VGreen Evo® motor. If the VGreen Evo motor does not restart automatically, disconnect power to the motor for approximately 3 minutes, and then reapply power to the motor. If this does not correct the situation, contact your local pool service professional.

In the event of a power outage or if power is cycled, the motor will start operating at hour one of the previously set schedule.

For example, when installed with a mechanical time clock the off/on trippers will restart the schedule daily when the on tripper applies power. If you wish to operate at another schedule or reset the current schedule, refer to section 4.5

### Schedule Set Mode.

# OF FLASHES	ERROR CONDITION	ERROR RESET CONDITION
1	Input voltage too high or low	Ensure input voltage is in the correct range.
2	VGreen Evo motor current too high	Cycle power to the VGreen Evo motor.
3	Internal temperature too high	Wait for temperature of the motor to cool down. Ensure VGreen Evo motor is clear of obstructions that limit proper ventilation.
4	VGreen Evo motor stalled	Check pump impeller and VGreen Evo motor fan for obstructions, then cycle power to motor.
5	Internal VGreen Evo motor failure	Cycle power to VGreen Evo motor. If problem persists, contact your local pool service professional.
6	Communication lost	Check low voltage connections between VGreen Evo motor and application board (3-wire harness).

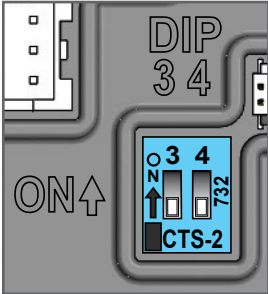
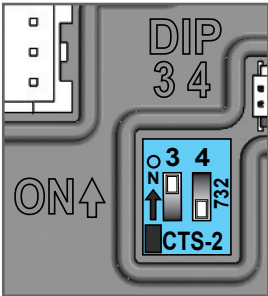
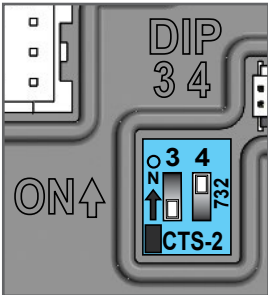
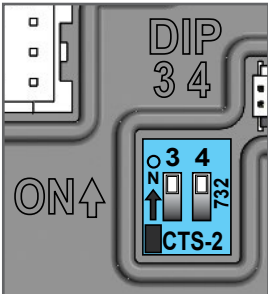

## 9.0 DIP SWITCH CONFIGURATION - QUICK START REFERENCE

DESIRED FUNCTIONALITY	DIP SWITCH POSITION
<p><b>Schedule Set A:</b></p> <p>8 pre-programmed operating schedules for the user to select from. Details can be found in Section 4.5.1.</p> <p>Dip Switch #3 OFF Dip Switch #4 OFF</p>	
<p><b>Schedule Set B:</b></p> <p>8 pre-programmed operating schedules compliant with the California Energy Commission 2021 regulations. Details can be found in Section 4.5.2.</p> <p>Dip Switch #3 ON Dip Switch #4 OFF</p>	
<p><b>Schedule Set C (Water Feature Mode):</b></p> <p>The VGreen Evo® motor will run at a single, user selected, speed until it is either paused or a different dip switch configuration is set. Details can be found in Section 4.5.4.</p> <p>Dip Switch #3 OFF Dip Switch #4 ON</p>	
<p><b>Schedule Set D (Century Connect™ Automation Mode):</b></p> <p>The VGreen Evo motor will be able to pair with a compatible automation system to run and set schedules. Details can be found in Section 4.5.5.</p> <p>Dip Switch #3 ON Dip Switch #4 ON</p>	

## 10.0 TROUBLESHOOTING GUIDE

SYMPTOM	POSSIBLE CAUSES	POTENTIAL SOLUTIONS
<b>VGREEN EVO® MOTOR FAILS TO START</b>	Mains voltage is not present	Replace fuse, reset breaker/GFI. Tighten mains wire connections.
	VGreen Evo motor shaft is locked	Check if the VGreen Evo motor can be rotated by hand and remove any blockage.
	VGreen Evo motor shaft is damaged	Replace VGreen Evo motor.
<b>VGREEN EVO MOTOR RUNS THEN STOPS</b>	Over temperature FAULT	Check that back of VGreen Evo motor is free from dirt and debris. Use compressed air to clean.
	Over current FAULT	VGreen Evo motor will automatically restart after 6 minutes.
<b>VGREEN EVO MOTOR IS NOISY</b>	Debris in contact with fan	Check that back of VGreen Evo motor is free from dirt and debris. Use compressed air to clean.
	Debris in strainer basket	Clean strainer basket.
	Loose mounting	Check that mounting bolts of VGreen Evo motor and pump are tight.
<b>VGREEN EVO MOTOR RUNS, BUT NO FLOW</b>	Impeller is loose	Check that VGreen Evo motor is spinning by looking at fan on back of VGreen Evo motor. If so, check that pump impeller is correctly installed.
	Air leak	Check plumbing connections and verify they are tight.
	Clogged or restricted plumbing	Check for blockage in strainer or suction side piping.
Check for blockage in discharge piping including partially closed valve or dirty pool filter.		





## Power Efficiency Solutions Regal Rexnord

531 North Fourth Street

Tipp City, OH 45371

Customer Service: 1-833-REGAL00

Email: [pooldist@regalrexnord.com](mailto:pooldist@regalrexnord.com)

[pool-motors.com](http://pool-motors.com)

[regalrexnord.com](http://regalrexnord.com)

\*The following trademarks or trade names are believed to be the trademarks or trade names of their indicated owners and are not controlled by Regal Rexnord Corporation: Hayward, EcoStar, OmniLogic, OmniPL and ProLogic – Hayward Industries, Inc.; Jandy, Fluidra, iQpump, Aqualink, iAqualink, and JEP-R – FLUIDRA, S.A.; Pentair, Easytouch, Intellitouch and Intelliconnect – Pentair, Inc.

Regal Rexnord, Century, Century Connect and VGreen Evo are trademarks of Regal Rexnord Corporation or one of its affiliated companies.

©2021, 2023 Regal Rexnord Corporation, All Rights Reserved. MCIM22124E • Form# C0065E • R14

For more information and updates on the VGreen Evo® motor, and Century Connect™ Automation Mode, scan the QR code.

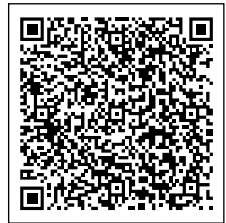

**RegalRexnord™**