



UltraUV™

ULTIMATE UV WATER SANITIZER

INSTALLATION & OPERATIONS MANUAL



IMPORTANT SAFETY INSTRUCTIONS: READ COMPLETELY BEFORE PROCEEDING.

When using this electrical equipment, basic safety precautions should always be followed, including the following:

WARNING:

- Follow all applicable electrical codes.
- Turn off power at main source before making any electrical connections or servicing the unit.
- To reduce the risk of electric shock, injury or death disconnect unit from power supply
- Follow the instructions or risk of serious injury or death could occur!



UV EXPOSURE & PROTECTION:

UV-A and UV-B radiation can have adverse short and long term effects on the eyes and skin. Never look directly at a UV lamp that is connected to a power source. Avoid UV skin exposure at all times.

 **UL LISTED**
Pool, Spa & Pond
Water Sanitizer 4BU1

 **EPA Registered**
#084221-AZ-001

Paramount
Pool Life. Simplified.™

295 East Corporate Place • Suite 100 • Chandler, AZ 85225
Toll Free: 1.800.621.5886 • Phone: 480.893.7607 • Fax: 480.753.3397
Paramount@1Paramount.com • www.1Paramount.com

004-422-0003-00 REV 031714

Table of Contents

Welcome	3
General Product Information	3
ULTRA UV System Sizing	3
Pond Sizing Considerations	3
Pond Sizing Chart	4
Pool, Spa, Fountain, Water Feature, Water Fall Sizing Chart.....	5
First Step In Starting Your Installation.....	6
Locating The Ultra UV Unit	6
Installing Inlet/Outlet Unions	6
Mounting The UV Unit On A Solid Base	6
Plumbing The Ultra UV Unit.....	7
Installing An Optional Flow Switch If The Top Of The Unit Is Below Water Level	8
Gluing Piping To The UV Unit	8
Providing Electrical Power To The Ultra UV Unit	8
Electrical Bonding (Grounding).....	9
Pressure Switch	9
Connecting Pressure Switch	10
System Start-Up.....	10
Water Chemical Balance	10
Upgrading The Output Of The Ultra UV Unit	10
Quartz Tube Maintenance	11
Scheduled UV Lamp(s) Replacement.....	15
Lamp Replacement Procedure	15
Winterization Of Your Ultra UV Unit	16
FAQs	17
Troubleshooting.....	18
Ultra UV Replacement Parts	23

WELCOME

The ULTRA UV Unit is designed for use in swimming pools, spas, fountains, water features, waterfalls, fish ponds and the like. It is not designed for use in potable (drinking) water installations. Use of this product in applications other than those indicated above will void your warranty and could be harmful to your health or the health of others.

GENERAL PRODUCT INFORMATION

Water circulates through the ULTRA UV chamber and around the quartz tube where the UV-C lamps (1 to 4 lamps depending on the model) are housed. The UV-C lamp emits a light wave spectrum (253.7 nm wavelength) to immediately inactivate 99.9% of micro-organisms such as Crypto, Giardia, other single celled waterborne microorganisms and algae which are resistant to chlorine. This provides a cleaner, clearer swimming environment with zero harmful by-products and dramatically reduces the amount of chlorine needed to maintain an adequate level of residual sanitizer. The ULTRA UV unit has been sized to produce these important UV rays in the same intensity as is required for Class A potable drinking water, which is 30,000 micro watts/cm². (30 mJ) Confirm the size unit your application needs by using the sizing charts on page 2 and 3, to obtain the proper maximum system killing power.

CAUTION: DO NOT USE THIS UNIT FOR POTABLE (DRINKING) WATER SANITATION.

ULTRA UV SYSTEM SIZING

In order to ensure that your ULTRA UV unit functions with the proper water exposure time to achieve the desired water sanitation, it is important to provide the proper water flow rate through the ULTRA UV unit. If water passes through the unit too quickly, the microorganism's exposure time to the UV lamp(s) produced rays will not be sufficient to obtain the desired rate of sanitation. The water flow rate through the UV unit is governed by the piping of your water vessel and the size and output of your circulation pump. Consideration to the application for the UV unit must be determined. Fish ponds, as an example, have different requirements than swimming pools, spas, water features, fountains, or waterfalls, as noted elsewhere in this manual

POND SIZING CONSIDERATIONS

Most fish pond experts agree that there is no simple or set formula for the sizing of circulation pumps and UV systems for fish ponds. The best advice is to consult a fish pond expert to determine what the flow rate for your pond should be, and use the appropriate sized ULTRA UV for that flow rate.

POND SIZING CHART

See Chart Below.

ULTRA UV Part Number		Maximum Flow Rate (GPM)	Maximum Flow Rate (m ³ /hr)	Max Pond Volume 2 Hr. Turnover (GPM)	Max Pond Volume 2 Hr. Turnover (m ³)	Max Pond Volume 3 Hr. Turnover (GPM)	Max Pond Volume 3 Hr. Turnover (m ³)
004-422-2025-00 004-422-2029-40 004-422-2021-00 004-422-2029-00	230V w/ 1 UV-C Lamp 230V w/ 1 UV-C Lamp w/SS Reactor 120V w/ 1 UV-C Lamp 120V w/ 1 UV-C Lamp w/SS Reactor	46	10.4	5520	20.9	8280	31.3
004-422-2026-00 004-422-2029-50 004-422-2022-00 004-422-2029-10	230V w/ 2 UV-C Lamps 230V w/ 2 UV-C Lamps w/SS Reactor 120V w/ 2 UV-C Lamps 120V w/ 2 UV-C Lamps w/SS Reactor	80	18.2	9600	36.3	14400	54.5
004-422-2027-00 004-422-2029-60 004-422-2023-00 004-422-2029-20	230V w/ 3 UV-C Lamps 230V w/ 3 UV-C Lamps w/SS Reactor 120V w/ 3 UV-C Lamps 120V w/ 3 UV-C Lamps w/SS Reactor	130	29.5	15600	59.1	23400	88.6
004-422-2028-00 004-422-2029-40 004-422-2024-00 004-422-2029-30	230V w/ 4 UV-C Lamps 230V w/ 4 UV-C Lamps w/SS Reactor 120V w/ 4 UV-C Lamps 120V w/ 4 UV-C Lamps w/SS Reactor	164	37.2	19680	74.5	29520	111.7

All capacities are nominal. Note: Multiple ULTRA UV units can be used for flow rates beyond those specified herein. (See page 7, Fig. 2a)

POOL, SPA, FOUNTAIN, WATER FEATURE, WATER FALL SIZING CHART

Swimming pools and similar water vessels are simple to calculate. See chart below.

ULTRA UV Part Number	Maximum Flow Rate (GPM)	Maximum Flow Rate (m3/hr)	Max Pool Volume 12 Hr. Turnover (Gallons)	Max Pool Volume 12 Hr. Turnover (m3)	Max Pool Volume 8 Hr. Turnover (Gallons)	Max Pool Volume 8 Hr. Turnover (m3)
004-422-2025-00 230V w/ 1 UV-C Lamp 004-422-2029-40 230V w/ 1 UV-C Lamp w/SS Reactor 004-422-2021-00 120V w/ 1 UV-C Lamp 004-422-2029-00 120V w/ 1 UV-C Lamp w/SS Reactor	46	10.4	33120	125.4	22080	83.6
004-422-2026-00 230V w/ 2 UV-C Lamps 004-422-2029-50 230V w/ 2 UV-C Lamps w/SS Reactor 004-422-2022-00 120V w/ 2 UV-C Lamps 004-422-2029-10 120V w/ 2 UV-C Lamps w/SS Reactor	80	18.2	57600	218.0	38400	145.4
004-422-2027-00 230V w/ 3 UV-C Lamps 004-422-2029-60 230V w/ 3 UV-C Lamps w/SS Reactor 004-422-2023-00 120V w/ 3 UV-C Lamps 004-422-2029-20 120V w/ 3 UV-C Lamps w/SS Reactor	130	29.5	93600	354.3	62400	236.2
004-422-2028-00 230V w/ 4 UV-C Lamps 004-422-2029-40 230V w/ 4 UV-C Lamps w/SS Reactor 004-422-2024-00 120V w/ 4 UV-C Lamps 004-422-2029-30 120V w/ 4 UV-C Lamps w/SS Reactor	164	37.2	118080	447.0	78720	298.0

All capacities are nominal

Note: Multiple ULTRA UV units can be used for flow rates beyond those specified herein. (See page 7, Fig. 2a)

FIRST STEP IN STARTING YOUR INSTALLATION

Inspect the ULTRA UV unit for damage, paying close attention to the quartz tube.

LOCATING THE ULTRA UV UNIT

Your unit can be installed indoors or outdoors. When considering the location for your ULTRA UV unit, keep it close to your power source. Check the silver product label for the voltage of the unit. The ULTRA UV unit will need to be powered from either a 120V/15A/50/60Hz or 230 V/15A/50/60Hz electrical circuit



Fig. 1

(which **MUST** match the unit power requirement noted on the silver product label on the ULTRA UV unit). **DO NOT CONNECT TO ELECTRICAL POWER NOT SPECIFIED FOR YOUR UNIT.** If the plug-in electrical outlet that your unit plugs into is outdoors and open to the weather, it will need to be an outdoor rated receptacle. The ULTRA UV 120V unit comes with an eight or ten foot long power cord. **DO NOT** use an extension cord. The 230V unit requires a permanent hard wire connection.

INSTALLING INLET/OUTLET UNIONS

The ULTRA UV unit comes with female socket glue-in inlets and outlet openings. ABS to PVC multipurpose glue and appropriate primer must be used to glue fittings into the ULTRA UV body. The 4 outlets (top) and 4 inlets (bottom) provide the most versatile piping alternatives for the installer. The ULTRA UV unit comes with (2) each 2 inch or 63mm inlet and outlet unions.

Multiple inlets and outlets can be used to manage higher flow rates.

NOTE: The use of multiple inlets/outlets will require additional unions. Use the plugs provided with the ULTRA UV in the unused inlets and outlets. To install the unions on to the ULTRA UV unit, glue and insert the unions spigot end into the Inlet and Outlet opening selected. Then, using the six plugs provided, glue the plugs into the remaining unused plumbing openings. Hand tightening the union nuts until snug is sufficient. **DO NOT OVER TIGHTEN.** Over tightening may break the molded plastic parts of the unions. Once you are confident that you have installed the Inlet and Outlet union halves successfully, you will be ready to glue your plumbing into the union sockets once the ULTRA UV unit is mounted to the mounting surface.

MOUNTING THE UV UNIT ON A SOLID BASE

Before you make the permanent plumbing connections be sure the ULTRA UV unit is on a solid level base making sure your plumbing connections align. After making your plumbing connections, anchor the unit to the base. **FAILURE TO PROPERLY SECURE THE UNIT MAY CAUSE NOISE OR VIBRATION.**

PLUMBING THE ULTRA UV UNIT

All plumbing methods are illustrated with and without the bypass option. Your ULTRA UV unit will need to be plumbed into the circulation system. The ULTRA UV unit is plumbed to the discharge side of the filter before the heater.



Fig. 2



Fig. 2

TYPICAL PLUMBING WITHOUT AND WITH BYPASS

The inlet is at the bottom of the unit and the outlet at the top. The maximum operating pressure for the ULTRA UV is 35 psi (2.4 BAR) (Figs. 2).



Fig. 2a

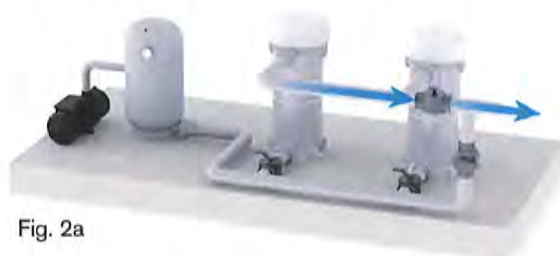

Fig. 2a

SERIES PLUMBING WITHOUT AND WITH BYPASS

Plumbing the ULTRA UV units in a series for large bodies of water with excessive flow rates (Figs. 2a).



Fig. 3



Fig. 3

MULTIPLE PORT PLUMBING WITHOUT AND WITH BYPASS

Be sure to use the appropriate amount of inlets and outlets available on the ULTRA UV to handle the maximum gpm / lpm rating of the pump that is circulating through the ULTRA UV unit. Using a bypass is another method for controlling the maximum flow (Fig. 3).

NOTE: THE ULTRA UV CAN BE PLUMBED WITH OR WITHOUT A BYPASS. THE BYPASS METHOD IS CONSIDERED TO BE THE PREFERRED METHOD. IT OFFERS EASIER SERVICING & REMOVAL FOR WINTERIZATION WHILE STILL ALLOWING WATER FLOW.



Fig. 3A



Fig. 3A

INSTALLING AN OPTIONAL FLOW SWITCH IF THE TOP OF THE UNIT IS BELOW WATER LEVEL

The pressure switch will always be on when the ULTRA UV unit is below water level. To prevent damage to the unit and its surroundings an optional flow switch must be installed.

If the ULTRA UV unit is plumbed on a bypass, the optional 2 inch Flow Switch (part # 004-402-0010-00), must be on the outlet side of the ULTRA UV unit and plumbed after the two way valve and before the tee into the return line (Fig. 3A).

GLUING PIPING TO THE UV UNIT

Two Inlet/Outlet unions are supplied. Your PVC supply piping should be glued into the union tail pieces using an appropriate primer and ABS to PVC cement. Inlet piping should be supported and should not rest solely upon the unions, to avoid stressing or breaking the unions. If the ULTRA UV unit is located with any portion of the unit below the surface of the body of water, then a **BYPASS VALVE IS MANDATORY** (Fig 2). Allow the glue to set following the glue manufacturers recommendations before pressure testing. Maximum test pressure for the ULTRA UV is 35 psi. If local codes require the pressure test to be higher than 35 psi, use the bypass to allow the ULTRA UV to be only left at 35 psi.

PROVIDING ELECTRICAL POWER TO THE ULTRA UV UNIT

The electrical power rating for your ULTRA UV unit is shown on the silver label located on the outside of the unit (Fig. 1). Check the label on your ULTRA UV unit for its power requirement before proceeding and make sure the supplied power meets the unit's electrical requirements. Connection to any power source other than that listed on the rating label will **VOID** your Limited Warranty.

If the electrical household power for your country is customarily 120V/50/60 Hz, then your units electrical plate should indicate this voltage. At 120V, the power draw is 2.6 Amps maximum for a 4 lamp system. This low power consumption makes operating your ULTRA UV unit very economical. Your ULTRA UV 120V unit is supplied with a eight to ten foot long weatherproof power cord terminating with a 3-prong grounded NEMA plug. A J box with a 6" lead wire is provided for a 230V installation. It is recommended that a ground fault circuit interrupter (GFCI) be installed in the electrical outlet or in the breaker panel serving the ULTRA UV unit (subject to your electrical codes). **Note:** Should the

electrical power cord of your ULTRA UV unit become frayed or damaged in the future, unplug it from the power receptacle and replace it immediately. Note: Some jurisdictions do not allow cord connection of these types of appliances. Check your countries electrical code. If hard wiring is required, then this work is best done by a licensed electrical service person.

If your country provides 230V/50/60Hz electrical household power, then your units should indicate 230V/50/60Hz supply power on the electrical plate on the front of the unit. In some instances, your unit will be supplied with the electrical plug on the power cord that is common to your country. Use the plug supplied where plug-in appliances are allowed. On a 230V use Seal Tight fittings with a J Box. A 6" of lead wire will be included. Remember, you **CANNOT** operate your ULTRA UV unit on any power supply other than that indicated on the unit's electrical plate.

ELECTRICAL BONDING (GROUNDING)

Locate the grounding lug next to the power cable (Fig. 4). To reduce the risk of electric shock, this terminal must be connected to the grounding means provided in the electrical supply service panel with a continuous copper wire equivalent in size to the circuit conductors supplying this equipment. To reduce the risk of electric shock, connect the local common bond grid in the area of the pool or spa to this terminal with an insulated or bare copper conductor not smaller than 6 AWG. The electrical installation is now complete.

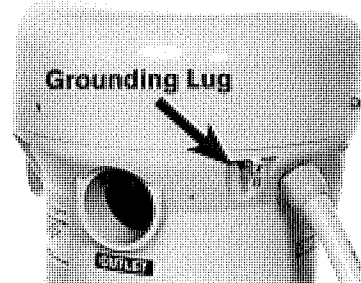

Fig. 4

DANGER - RISK OF ELECTRICAL SHOCK - RISK OF INJURY OR DEATH IF ELECTRICAL INSTALLATION IS NOT DONE PROPERLY.

Paramount Recommends you have this important work done by a Licensed Electrical Technician!

PRESSURE SWITCH

The ULTRA UV unit is equipped with a pressure switch that does not allow the UV lamp(s) inside the unit to light unless there is at least 5 PSI (0.35 Bar) inside the ULTRA UV reactor chamber. This will ensure that the lamp(s) will not illuminate when the ULTRA UV unit does not have water flowing through the reactor or if it is empty. The lamps will only illuminate when the pressure switch senses a minimum of 5 psi (0.35 bar).

CONNECTING PRESSURE SWITCH

Disconnect the power to the ULTRA UV unit. Remove the cover and locate the pressure switch (Fig. 5). Locate the lead with the female spade connector that comes up through a rubber grommet in the black metal plate (Fig. 6). Attach the female spade to the unpopulated male spade closest to the bottom plate on the pressure switch (Fig. 7). Then replace the cover and restore power to the unit. Look through the glow ring on the center of the unit to check that all lamps are lit. Never look directly at the lamps. Serious injury will occur.

SYSTEM START-UP

The quartz tube in the unit is fragile. To prevent damage to the quartz tube isolate the ULTRA UV with the recommended bypass valve then turn on the circulation system to ensure all debris is blown out of the plumbing. Open the bypass and check for plumbing leaks and/or leaks caused by damaged quartz tube.

WATER CHEMICAL BALANCE

If you have installed your ULTRA UV unit on any water vessel other than fish ponds or ponds with live plants, it is important that you check and adjust the chemical balance of the water. The ULTRA UV unit dramatically reduces the need for chemical sanitizers, but a minimum sanitizer residual must be maintained.

UPGRADING THE OUTPUT OF THE ULTRA UV UNIT

One of the exclusive features of the ULTRA UV system is the ability to increase the UV output of the unit by adding additional lamps. Up to three additional lamps can be added to a single lamp system. This is accomplished easily by adding lamps and or adding additional ballasts and lamps.



Fig. 5



Fig. 6



Fig. 7

CONSUMER OPERATING INSTRUCTIONS

QUARTZ TUBE MAINTENANCE

Cleaning quartz tube. The quartz tube requires cleaning every 6 months to ensure optimum performance.

1. Turn off all power to the ULTRA UV unit and all other pool equipment. Unplug the unit from its power receptacle or turn OFF the circuit breaker that is the ULTRA UV's power source. Before proceeding to step 2 allow at least 15 minutes for the bulbs in the unit to cool off.



Fig. 8

2. **NEVER REMOVE THE ELECTRICAL ENCLOSURE COVER WITHOUT FIRST UNPLUGGING OR TURNING OFF THE CIRCUIT BREAKER (POWER SOURCE) FOR THE ULTRA UV UNIT. NEVER REMOVE THE ULTRA UV UNIT'S COVER WITHOUT TURNING OFF THE PUMP.**

Remove the three screws on the plastic cover and lift up on the cover to remove. (Fig. 8)

3. With the cover off unplug the lamp connectors from the lamps by pressing the release and pulling the Mate-N-Lok connectors apart to separate, repeat to disconnect all lamps (Fig. 9, 10).



Fig. 9



Fig. 10

YOU MUST WEAR PROTECTIVE RUBBER GLOVES. DO NOT HANDLE A HOT LAMP OR SERIOUS BURNS WILL OCCUR. DO NOT TOUCH THE GLASS PART OF THE LAMP AS BODY OILS WILL CREATE HOT SPOTS & GREATLY SHORTEN LAMP LIFE. (Fig. 11)

4. Carefully lift the lamp(s) from the quartz tube. Set aside in a safe area to avoid breaking or chipping the lamp(s) (Fig. 11).



Fig. 11

5. Turning counter clockwise, unscrew the round aluminum sealing nut. If there isn't enough clearance to unscrew the aluminum sealing nut, unscrew one side of one ballast and loosen the screw on the other side (Fig. 12). Swing ballast out of the way to get a better grip or to use a tool. Remember to replace ballast.



Fig. 12

6. Carefully lift the compression washer from the top of the quartz tube making sure not to lose the black gasket that cushions the edge of the quartz tube (Fig 13).



Fig. 13

7. Wearing protective rubber gloves, hold quartz tube with both thumbs inside and pull up (Fig. 14). Once the O-ring breaks free, the quartz tube should lift out easily (Fig. 15). **Warning:** The quartz tube is fragile, be sure to handle it with proper care and do not set it down on a hard surface.



Fig. 14

8. Using protective rubber gloves and eye wear use a good shower/tub cleaner or a solution of white vinegar and water to clean the outside of the quartz tube (Fig. 16). If the inside of the quartz tube is moist



Fig. 15

or needs cleaning use the same cleaning method. The inside of the quartz tube must be completely dried before reassembly.

DO NOT USE ABRASIVE CLEANERS OR PADS.

9. Inspect the quartz tube carefully for any cracks or chips and replace the quartz tube if any are found. The ULTRA UV unit is supplied with 3 additional O-rings.

Do not use any other O-ring at any time for sealing the quartz tube doing so can result in a leak and possible damage to your UV unit.

10. To reinstall the quartz tube place the O-ring 2 inches from the top of the outside of the quartz tube (Fig. 17). Place the quartz tube, with the O-ring in place, back into the unit. Gently lower the quartz tube into the unit until the O-ring makes contact with the top of the inside of the black threaded quartz tube sealing sleeve (Fig. 18).

11. Making sure the black gasket that was nested inside the aluminum compression washer is in place to cushion the edge of the quartz tube (Fig. 19).



Fig. 16



Fig. 17



Fig. 18



Fig. 19

12. Then place the aluminum compression washer on the quartz tube. Press down on the aluminum compression washer with an even steady pressure (Fig. 20). This will roll the O-ring into the area between the inside of the black threaded sleeve and the quartz tube. Check and make sure it is seated evenly around the circumference of the quartz tube. Screw on the quartz sealing aluminum nut hand tight plus $\frac{1}{2}$ turn.
13. Carefully replace the lamp(s) in the quartz tube (Fig. 21). Reattach ballast if you've disconnected in step 5. Connect lamp(s) to ballasts (Fig. 22). Replace the plastic cover and the three screws.



Fig. 20



Fig. 21



Fig. 22



Fig. 23

SCHEDULED UV LAMP(S) REPLACEMENT

The UV lamps have a useful life of approximately 13,000 hours and should be replaced at that time. Even though the lamp(s) may be glowing after 13,000 hours of operation they have reached the end of their useful life.

LAMP REPLACEMENT PROCEDURE

1. Refer to page 8, steps 1-3 before removing lamp(s) (Fig. 23).
2. You must wear protective rubber gloves to avoid any body oils on lamp(s). Oils will create hot spots and greatly shorten lamp(s) life. Carefully lift the lamp(s) from the quartz tube (Fig. 24).
3. With the lamp(s) removed from the unit, pull off the black booties from the bottom of each lamp(s) and remove the bottom and top yellow aligning disk (Fig. 25, 26, 27). Retain both yellow aligning disks. New replacement lamp(s) includes black booties and O-rings.
4. Discard lamp(s) appropriately. Visit www.lamprecycle.org for instructions on disposal. Repeat the steps in reverse order to reinstall the lamp(s).



Fig. 24



Fig. 25



Fig. 26



Fig. 27

WINTERIZATION OF YOUR ULTRA UV UNIT

If you are in a climate where you run your pool, spa, water feature, pond year round, be sure that the flow to the unit continues during any periods of below freezing temperatures. Failure to do so will cause damage to the unit.

Option #1 - Removing the unit for the winter. Turn off the power to the unit. Remove the drain plug and allow all of the water to drain from the unit (Fig. 28). Disconnect the unions on the plumbing to ensure that the unit is completely drained. Now, with the power off, disconnect the unit from its power source and place the drained unit in a safe place that has a sustained temperature above freezing. Reinstall after the temperatures are considerably above freezing.

Option #2 - Leaving the unit in place for the winter. Turn off the power to the unit. Remove the drain plug and allow all of the water to drain from the unit. Disconnect the unions on the plumbing to ensure that the unit is completely drained. There is a cup in the bottom of your unit that the quartz tube nests in. This cup does not drain completely (Fig. 28). To remove the water from this cup you must first remove the lamp array and quartz tube (See page 11). Turn the unit on its side with the unions facing down until all of the water has drained. Reconnect the unit, replace the drain plug, quartz tube, lamps, and cover. You may store the lamps and quartz tube in a safe place.

Another way to remove the water from the unit is to insert a wet dry vac into the unit and suck out the water from the cup in the bottom of the unit.

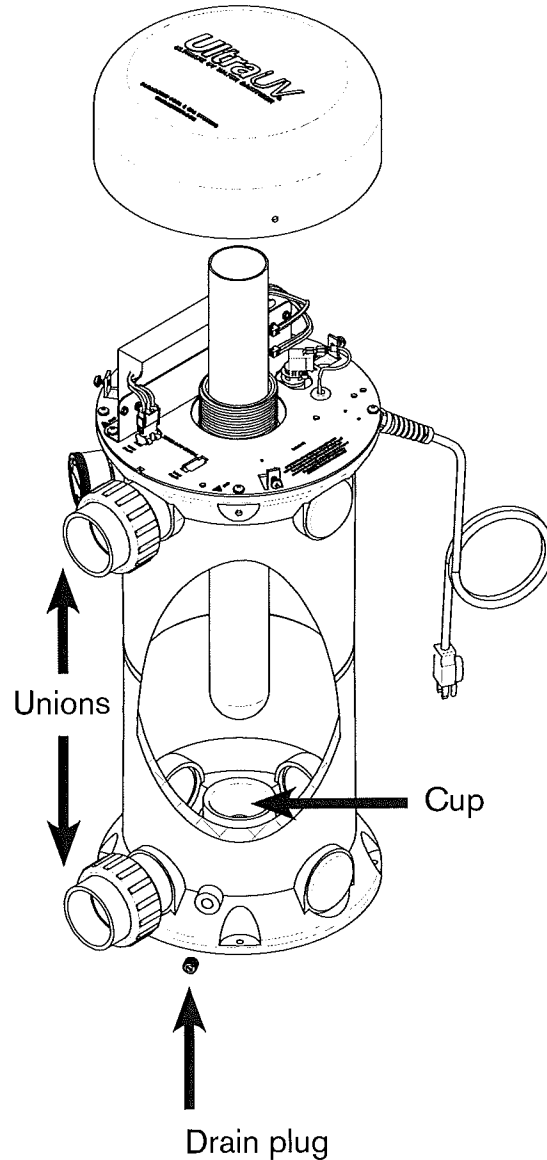

Fig. 28

FAQs

IS THE ULTRA UV UNIT DESIGNED FOR USE IN SALT WATER APPLICATIONS?

Yes. Paramount's ULTRA UV units without the optional stainless steel reactor reflectors are fully compatible with all salt water environments. The quartz tube could require more frequent cleaning in a salt water environment.

DO I NEED TO TURN MY ULTRA UV UNIT OFF WHEN I BACKWASH MY FILTER?

No. the unit does not energize because it is not under pressure during backwashing. If you have a cartridge filter, turn off the power.

WHAT WOULD SHORTEN THE LAMP LIFE OF THE ULTRA UV UNIT?

Multiple daily cycles can shorten lamp life.

IS THERE ANY RESIDUAL EFFECT FROM UV?

No. All of the sanitizing is done in the reactor.

CAN THE ULTRA UV UNIT BE MOUNTED HORIZONTALLY?

No, vertical mounting is required to maintain the weatherproof integrity of the electrical enclosure cover.

CAN THE ULTRA UV UNIT BE INSTALLED BELOW THE VESSEL'S WATERLINE?

Yes. But if the unit is below water level you must install a flow switch. See page 8.

CAN MULTIPLE UNITS BE USED TOGETHER FOR LARGER SYSTEMS?

Yes, you can add any number of ULTRA UV units to a plumbing bypass manifold. See page 7.

MUST I USE A GFCI (GROUND FAULT CIRCUIT INTERRUPTER) WITH MY UV UNIT?

Yes. But consult your local and national electrical codes as there could be other requirements. You must use a G.F.C.I. receptacle on the 120v plug in unit. When using a 230v hardware unit, use a 15amp G.F.C.I. breaker.

TROUBLESHOOTING

IDENTIFYING AND CORRECTING SYSTEM PROBLEMS

The list below will help guide you through any problems you may have at time of initial installation or in the future. For additional assistance, contact your supplier or Paramount Pool & Spa Systems, 295 East Corporate Place, Chandler AZ 85225.

THE UV LAMP(S) WILL NOT COME ON

If this occurs upon initial start-up, the problem could be caused by a number of issues. All ULTRA UV units come with the pressure switch disabled. Make sure the electric is off, remove the cover and check to see that both wires are connected to the pressure switch. See page 10.

- a. The pressure switch is open. This can be caused by low pressure in your system. Make sure the pump is ON (the UV lamp(s) will only light when there is 5 PSI (0.35 Bar) water pressure inside your ULTRA UV unit's reactor). Verify that the pressure gauge reads 5 PSI or more. If it does not read at least 5 PSI, reduce the flow exiting the ULTRA UV unit by partially closing the valve on the discharge piping exiting the ULTRA UV unit. This will increase the pressure inside the ULTRA UV reactor. To check the pressure switch operation, unplug or turn off the breaker, remove the enclosure cover on the top of the unit. Move the wire on the pressure switch from the bottom post to the unused post on the top. Turn on the power and if the lamps illuminate the pressure switch is a bad.
- b. The UV lamp(s) has/have become disconnected from the lamp connector(s). Disconnect the power servicing the ULTRA UV unit, open the electrical enclosure cover and confirm the lamp connector(s) is/are firmly locked together. At the same time, check all exposed wires for a possible loose connections. Re-establish power ONLY after the electrical enclosure cover has been re-installed on the ULTRA UV unit.
- c. Verify that the electrical cord is plugged into an energized electrical outlet or properly connected to the power source. Test the electrical outlet. You should confirm the availability of the same power as indicated on the electrical label on your ULTRA UV unit.

THE UV LAMP(S) IS/ARE NO LONGER ON

If this occurs after the unit has been operating successfully for a period of time.

- a. One or more lamps have burned out. Replace the UV lamp(s).
- b. A ballast has burned out. Contact your supplier or Paramount for assistance in obtaining a new ballast.
- c. Verify that the electrical outlet where the ULTRA UV unit is plugged into has the proper voltage and the cord is securely plugged into the outlet or connected to the power source.

- d. Verify that the GFCI has not tripped. To verify the operating state of the GFCI, trip the GFCI manually and reset it manually. The GFCI should reset. If it does not, it indicates a fault to ground in the electrical circuit or the ULTRA UV unit itself. Contact your supplier for assistance.
- e. The ballasts have internal protection that will power down the lamps in the case of an electrical event. Power down the unit for 5 minutes. This will reset the internal protection. When the power is returned, the internal protection is reset.

THE UV LAMP(S) STAYS ON WHEN THE PUMP IS OFF

The ULTRA UV unit is equipped with a safety pressure switch that turns the UV lamp(s) OFF when the pump is turned OFF. This function guards against having the lamp(s) lit accidentally when the electrical enclosure cover is removed and the electrical power to the ULTRA UV unit is still ON. This also serves to ensure that there is water flowing in the ULTRA UV unit's reactor chamber to cool the lamp(s) and extend lamp life, before the lamp(s) is/are turned ON.

- a. If the top of a ULTRA UV unit is located below the water level of the pond or pool, there is a static head of water that causes pressure to be found inside the wet chamber. This static head of pressure closes the pressure switch and the lamp(s) stays lit even when the pump is OFF. In this instance, you need not utilize the pressure switch, as the lamp(s) will always be operating with the reactor full of water. The pressure switch may be jumped by first unplugging the ULTRA UV unit from electrical power, removing the electrical enclosure cover, then moving the insulated wire pressure connector attached to the bottom tab of the pressure switch (Fig. 30) to the unused tab of the brass two prong tab on the top of the pressure switch (Fig. 31). This then bypasses the pressure switch. Power can be restored to the ULTRA UV unit once the electrical cover is reinstalled on the unit. **CAUTION:** With the pressure switch removed from the electrical circuit, only remove the electrical enclosure **AFTER** the power has been removed from the ULTRA UV unit, as the lamp(s) will remain ON until electrical power is removed from the ULTRA UV unit.



Fig. 30



Fig. 31

- b. If the ULTRA UV unit is located above the water level of the pool or pond and the lamp(s) stay(s) lit when the pump is OFF, replace the pressure switch.

THE WATER IS GREEN

Green water is an indication that the UV rays generated by the ULTRA UV unit are not effective or are not being generated by the UV lamp(s).

- a. Check the lamp(s) to make sure all lamps in your system are ON (by viewing the lamp(s) through the clear viewing band on the center of the reactor. If all lamps are not ON, follow the procedures above regarding the UV lamp not lighting.
- b. Run your unit longer. If your unit is operating on a time clock, run the circulation pump longer to allow the ULTRA UV unit to function fully.
- c. Clean the quartz tube(s).
- d. Replace the UV lamp(s) nearing the 13,000 hour useful lamp life. After 13,000 hours of operation, the UV lamp(s) are only 80% as effective as when new. This is normal for all long life low-pressure type UV lamps, which are the longest useful life lamps available for this type of application.
- e. If your ULTRA UV unit is installed on a swimming pool, shock the pool with the sanitizing chemical you normally use and balance the pool water as per your chemical manufacturer's specifications.
- f. Your unit is not sized for the flow and duration specific to your pool.

THE GFCI HAS TRIPPED

If you have installed a GFCI on your ULTRA UV application, the GFCI will protect the ULTRA UV unit and any other equipment on the same electrical circuit from any fault to ground, the same as the electrical breaker protects the total electrical circuit from a short. When the GFCI trips, it is an indication that there is an electrical problem that must be corrected to provide a safe operating environment for your installation. Follow the instructions of the GFCI manufacturer for more information on correcting the issue if the problem is with the GFCI.

- a. If you suspect that the problem is with the ULTRA UV unit, disconnect the ULTRA UV unit from the electrical receptacle. Reset the GFCI at the breaker panel or at the receptacle. If the GFCI does not reset, have the G.F.C.I replaced by a licensed electrician. If the GFCI does reset, first run the circulation pump, and if no GFCI trip is encountered, plug the ULTRA UV unit into the electrical receptacle and make sure the pump is ON. If the GFCI trips, it is an indication that there is a ground fault inside the ULTRA UV unit. Follow the instructions previously given for opening the electrical enclosure cover and inspecting the ULTRA UV unit. Call a qualified technician.

- b. If water is present inside the electrical enclosure cover, it will trip the GFCI. Following instructions given previously to remove the quartz tube(s), inspect for quartz tube cracks or breakage or for a bad quartz tube seal. Replace the quartz tube if it is cracked or broken. If not reseal it. See page 11.
- c. If the ULTRA UV unit trips when performing the test noted in Sec. (a) above, you can check to determine if a UV lamp is the GFCI trip cause by unplugging the individual lamp from the lamp connector, then place the electrical enclosure cover back on the ULTRA UV unit and power up the circulation pump. If the GFCI does not reset, then the problem is either with the remaining lamp(s) or with a ballast. Remove all the lamp connectors and reset the GFCI after replacing the electrical enclosure. If the GFCI still trips, unplug all ballasts. If the GFCI resets, then plug in first one ballast, and if your unit has two ballasts, then the second ballast after the first ballast has been tested. If either ballast trips the GFCI, then replace that ballast. Refer to page 23 for the proper ballast part number.

Reset the GFCI and if it does not trip, attach the electrical plug to a UV lamp. (One at a time if multiple lamps are present in your ULTRA UV unit.) If it trips with the lamp lit, it indicates that a UV lamp is causing the fault to ground. Replace the UV lamp.

THE ULTRA UV UNIT MAKES NOISE WHEN OPERATING

This is an indication of the ULTRA UV unit not being properly attached to a firm mounting base of concrete using bolts (not supplied) placed through the mounting holes in the ULTRA UV unit base. Attach the ULTRA UV unit correctly to a firm base as described in page 6.

WATER IS DRIPPING FROM THE ELECTRICAL ENCLOSURE COVER

Water exiting the unit through the electrical enclosure cover can be attributed to either (a) a bad quartz tube seal, or (b) a broken or cracked quartz tube. Check the quartz tube seal and quartz tube as instructed in page 11.

SPECIFICATION NOTICE

Due to Paramount's commitment to continual product improvement, all product descriptions or specifications noted herein are subject to change without notice.



LIMITED WARRANTY

ULTRA UV water sanitizers are covered under a 2 year Limited Warranty.

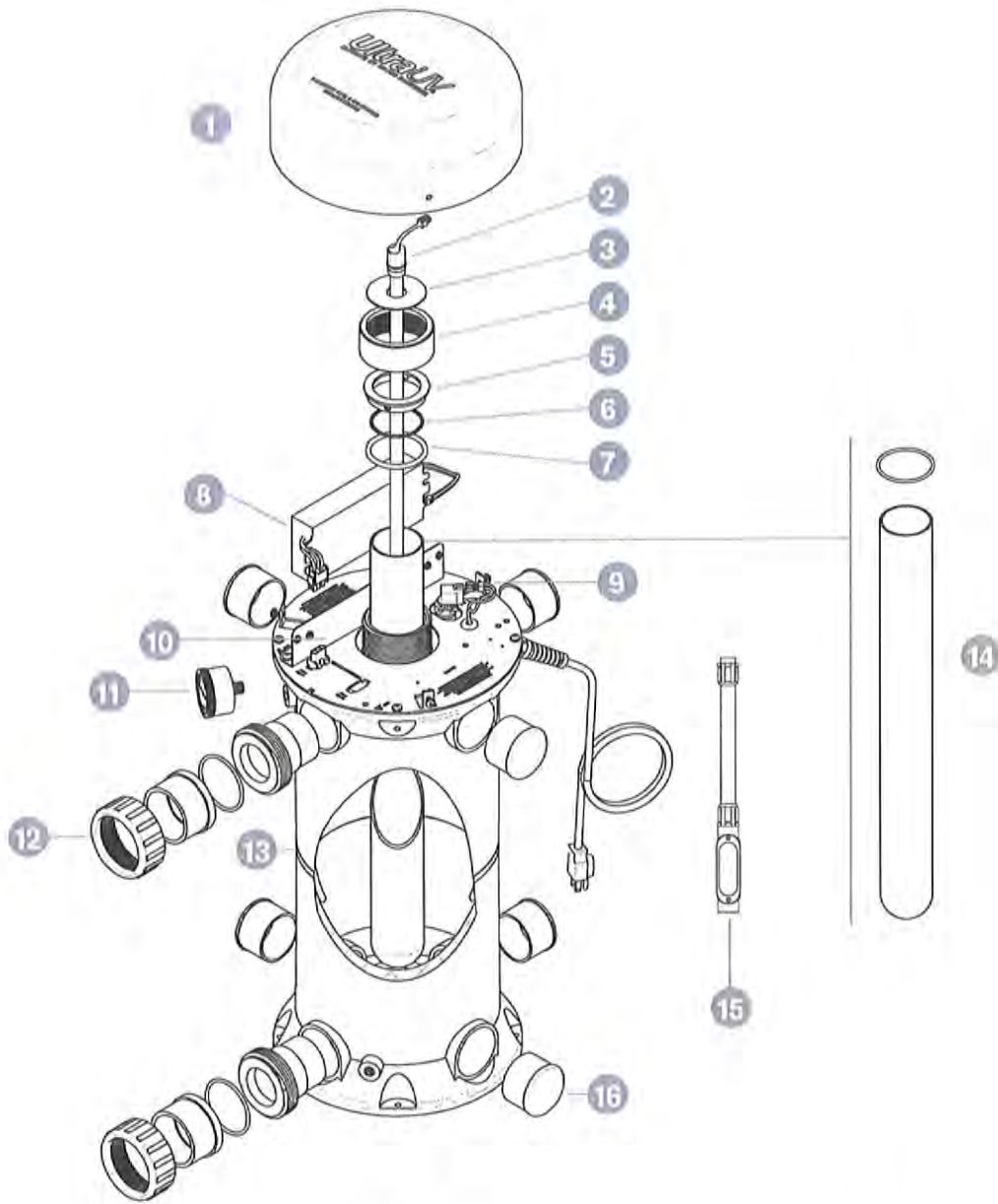
IMPORTANT SAFETY INSTRUCTIONS SAVE THESE INSTRUCTIONS

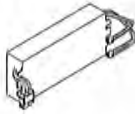
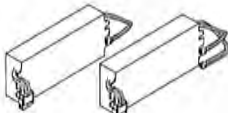
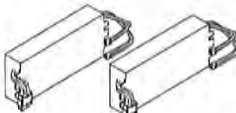

Lamp Unit Configurations

- 
 - 1 Lamp unit requires 1 single lamp ballast
 - 
 - 2 Lamp unit requires 1 dual lamp ballast
 - 
 - 3 Lamp unit requires 1 single lamp ballast
1 dual lamp ballast
 - 
 - 4 Lamp unit requires 2 dual lamp ballast
- 

12
2" Union Kits



63mm Union Kits
- 

17



18
Optional Flow Switch

ULTRA UV REPLACEMENT PARTS

	Paramount Part#	Description
1	005-422-2009-11	Cover
2	005-422-5104-00	UV Lamp
3		Centering Disk
4		Aluminum Sealing Nut
5		Compression Washer
6		Compression Washer O-Ring
7	005-422-5103-00	Quartz Tube Seal O-Ring, 3 Pack
8	005-422-2009-00	Program Start Voltage Sensing Ballast, 1 Lamp
8	005-422-2009-01	Program Start Voltage Sensing Ballast, 2 Lamp
9	005-422-2009-10	Pressure Switch
10	005-422-9010-00	Ballast Mounting Bracket
11	005-422-2009-05	Pressure Gauge
12	005-422-2009-06	2" Union Kits
12	005-422-2009-07	63mm Union Kits
13	005-422-3000-00	Replacement Housing
14	005-422-2009-09	Quartz Tube With Seal Kit
15		230V J Box & Flex Conduit
16	005-422-2009-08	2" Blanking Plug
17	005-422-2009-04	Screw Kits
18	004-402-0010-00	2" Flow Switch (Optional)



Paramount
Pool Life. Simplified.

ULTRA UV Ultraviolet Water Sanitizer WARRANTY CERTIFICATE

In compliance with the Magnuson-Moss Warranty-Federal Trade Commission Act (Public Law 930637, Paramount Pool & Spa Systems (PP&SS) provides the following limited warranties.

CONDITIONS

This limited warranty shall be subject to the original owner complying with the following conditions:

PP&SS warrants to original owner, materials, and equipment to be free of defects for a period of two (2) years from the date of swimming pool start-up or retail purchase. The materials, parts and/or related component parts supplied or distributed by PP&SS are covered under this two (2) year limited warranty. (PVC plumbing installed, labor, material and all other work performed by contractors is not covered under PP&SS Warranty.) PP&SS offers in field warranty service through a network of authorized Warranty Service Stations (W.S.S.) for one (1) year from the date of swimming pool start up or retail purchase. This warranty service must be arranged through your builder or retailer with Paramount. There is no reimbursement for any labor charges incurred outside of the Paramount W.S.S. network.

Replacement parts are warranted for a period of one (1) year from date of purchase and are not sold with any field service program.

REPLACEMENT CONDITIONS

Contact PP&SS for an RMA number, and return it to PP&SS. Ship part in question freight pre-paid, and upon confirmation of defect, PP&SS will repair or replace the PP&SS warranted item at no charge to the original owner. The repaired or replaced PP&SS item will be returned to the original owner with the return freight paid by original owner. Labor to re-install the repaired or replaced item is the sole responsibility of the owner.

LIMITATIONS

No warranty extends to any part of the PP&SS parts or components which is caused by any of the following conditions or events:

1. Defects or failures caused by abuse, lack of responsible care, lack of necessary maintenance, improper operation, vandalism, acts of God.
2. Damages or failures caused by abuse, lack of responsible care, lack of necessary maintenance, improper operation, vandalism, acts of God.
3. PP&SS expressly denies any responsibility or liability for incidental or consequential damages arising out of, or as a result of, use or ownership of your PP&SS parts or as a result of use or ownership of your PP&SS parts or components, or other related products covered under this limited warranty.
4. Any defects caused by acts of God, such as storms, earthquakes, ground movement, or freezing, etc., that are beyond the normal conditions.
5. Installation of the PP&SS System by a non-authorized installer may render this warranty null and void.
6. Mechanical abuse
7. Lamp failure after 24 months of operation
8. Improper installation
9. Glass component breakage
10. Improper operating voltage
11. Freeze damage
12. Operation at pressures greater than 45 psi (3bar)

Some states do not allow the exclusion or limitation of incidental or consequential damages, so the above limitations or exclusions may not apply to you. Implied warranties are limited in duration to the duration of the written limited warranty here within. Some states do not allow limitations on how long an implied warranty lasts, so the above limitations may not apply to you. This warranty gives you specific legal rights, and you may also have other rights that may vary from state to state.



UltraUV™

ULTIMATE UV WATER SANITIZER

OWNER'S MANUAL LAMP REPLACEMENT



IMPORTANT SAFETY INSTRUCTIONS: READ COMPLETELY BEFORE PROCEEDING.

When using this electrical equipment, basic safety precautions should always be followed, including the following:

WARNING:

- Follow all applicable electrical codes.
- Turn off power at main source before making any electrical connections or servicing the unit.
- To reduce the risk of electric shock, injury or death disconnect unit from power supply
- Follow the instructions or risk of serious injury or death could occur!



UV EXPOSURE & PROTECTION:

UV-A and UV-B radiation can have adverse short and long term effects on the eyes and skin. Never look directly at a UV lamp that is connected to a power source. Avoid UV skin exposure at all times.

 LISTED
Pool, Spa & Pond
Water Sanitizer 4BU1

 EPA Registered
#084221-AZ-001

295 East Corporate Place • Suite 100 • Chandler, AZ 85225
Toll Free: 1.800.621.5886 • Phone: 480.893.7607 • Fax: 480.753.3397
Paramount@1Paramount.com • www.1Paramount.com
004-027-8713-00 REV 031714

Paramount
Pool Life. Simplified.

WATER CHEMICAL BALANCE

If you have installed your ULTRA UV unit on any water vessel other than fish ponds or ponds with live plants, it is important that you check and adjust the chemical balance of the water. The ULTRA UV unit dramatically reduces the need for chemical sanitizers, but a minimum sanitizer residual must be maintained.

UPGRADING THE OUTPUT OF THE ULTRA UV UNIT

One of the exclusive features of the ULTRA UV system is the ability to increase the UV output of the unit by adding additional lamps. Up to three additional lamps can be added to a single lamp system. This is accomplished easily by adding lamps and or adding additional ballasts and lamps.

SCHEDULED UV LAMP(S) REPLACEMENT PROCEEDURE

The UV lamps have a useful life of approximately 13,000 hours and should be replaced at that time. Even though the lamp(s) may be glowing after 13,000 hours of operation they have reached the end of their useful life.

1. Turn off all power to the ULTRA UV unit and all other pool equipment. Unplug the unit from its power receptacle or turn OFF the circuit breaker that is the ULTRA UV's power source. Before proceeding to step 2 allow at least 15 minutes for the bulbs in the unit to cool off.
2. **NEVER REMOVE THE ELECTRICAL ENCLOSURE COVER WITHOUT FIRST UNPLUGGING OR TURNING OFF THE CIRCUIT BREAKER (POWER SOURCE) FOR THE ULTRA UV UNIT. NEVER REMOVE THE ULTRA UV UNIT'S COVER WITHOUT TURNING OFF THE PUMP.** Remove the three screws on the plastic cover and lift up on the cover to remove. (Fig. 1)
3. With the cover off unplug the lamp connectors from the lamps by pressing the release and pulling the Mate-N-Lok connectors apart to separate, repeat to disconnect all lamps (Fig. 2).

YOU MUST WEAR PROTECTIVE RUBBER GLOVES. DO NOT HANDLE A HOT LAMP OR SERIOUS BURNS WILL OCCUR. DO NOT TOUCH THE GLASS PART OF THE LAMP AS BODY OILS WILL CREATE HOT SPOTS & GREATLY SHORTEN LAMP LIFE.

4. Carefully lift the lamp(s) from the quartz tube (Fig. 3). With the lamp(s) removed from the unit, pull off the black booties from the bottom of each lamp(s) and remove the bottom and top yellow aligning disk (Fig. 4, 5, 6). Retain both yellow aligning disks. New replacement lamp(s) includes black booties and O-rings.
5. Discard lamp(s) appropriately. Visit www.lamprecycle.org for instructions on disposal. Repeat the steps in reverse order to reinstall the lamp(s).



Fig. 1



Fig. 2

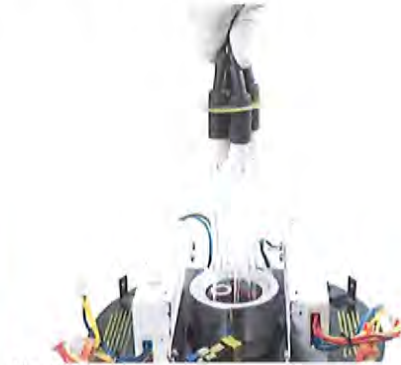

Fig. 3



Fig. 4



Fig. 5



Fig. 6